

All information given are for reference only.

40 t

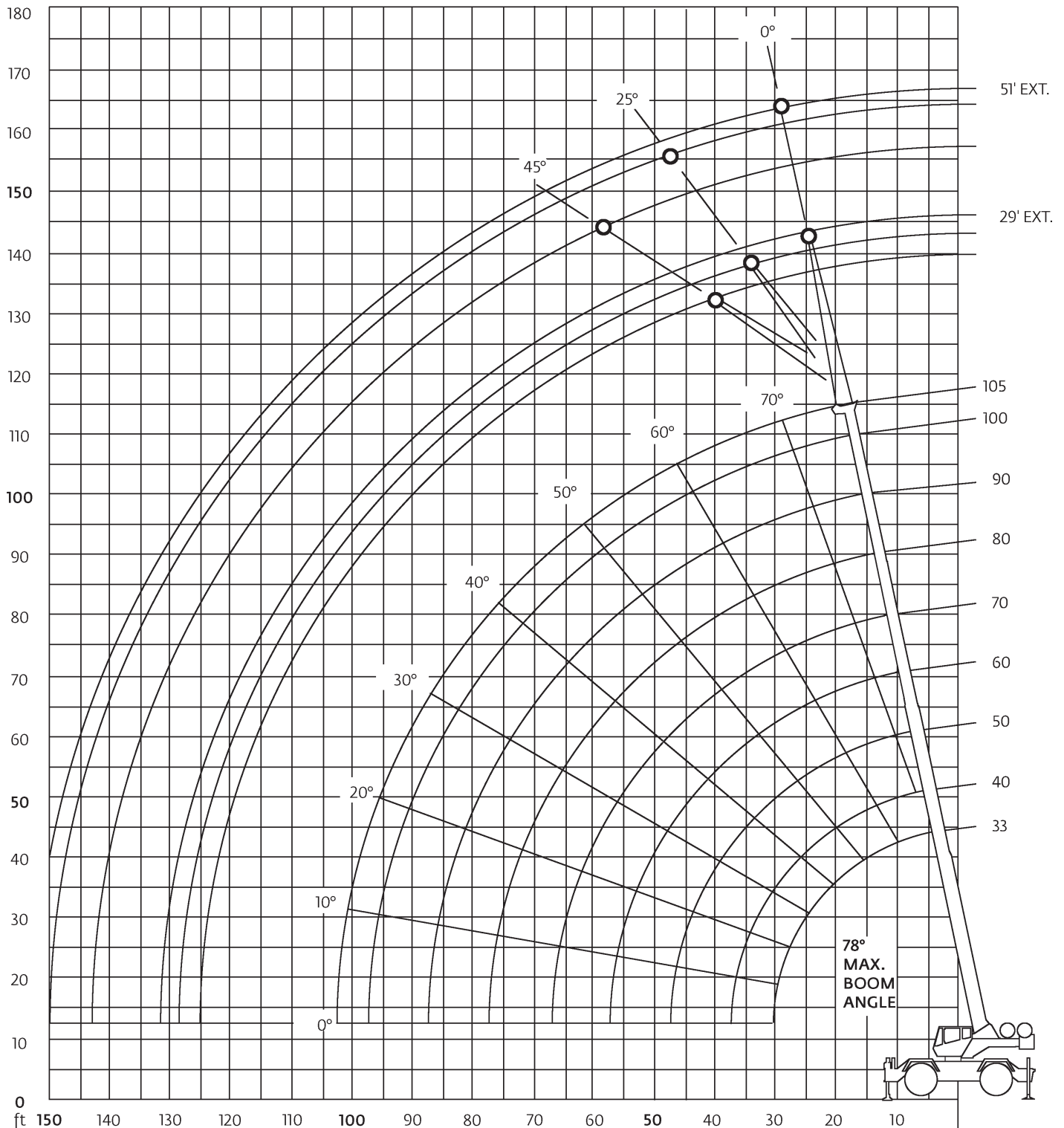

33-105 ft

12,250 lbs

22'4" x 22'6"

360°
85
85%

ft	33	40	50	60	70	80	90	100	105	ft
10	80	73.5	67.2							10
12	77.75	69.5	62.3	56.1						12
15	69.05	65.55	57.3	51.8	45.2					15
20	50.5	50.95	51.4	44.5	38.55	34.45	31.4			20
25	38.3	38.85	39.35	39.65	37.1	29.85	27.25	21	18.35	25
30		30.7	31.2	31.5	31.7	26.35	24.1	21	18.35	30
35			25.4	25.75	26	23.65	21.5	19.15	18.35	35
40			20.85	21.2	21.6	21.35	19.4	16.65	17.3	40
45				17.1	17.35	17.3	17.3	14.65	15.75	45
50				13.95	14.15	14.2	14.2	13	14.3	50
55					11.7	11.75	11.85	11.9	12	55
60					9.73	9.87	9.98	10.1	10.15	60
65						8.3	8.44	8.6	8.68	65
70						6.96	7.17	7.34	7.43	70
75							6.08	6.29	6.39	75
80							5.13	5.38	5.49	80
85								4.58	4.72	85
90								3.88	4.02	90
95									3.4	95

All information given are for reference only.

Rough Terrain Cranes

Grove RT 640 E



40 t



105 ft



29/51 ft



12,250 lbs



22'4"x22'6"



360°

85

85%

ft	0°	29 25°	45°	0°	51 25°	45°	ft
30	9						30
35	9			6			35
40	9	8		6			40
45	9	7.56	5.66	6			45
50	8.76	7.17	5.6	6			50
55	8.03	6.82	5.5	6	4.12		55
60	7.38	6.5	5.3	6	3.9		60
65	6.77	6.21	5.18	6	3.71	2.74	65
70	6.21	5.95	4.89	5.62	3.53	2.66	70
75	5.71	5.71	4.62	5.21	3.37	2.58	75
80	5.25	5.5	4.37	4.86	3.22	2.52	80
85	4.79	5.3	4.1	4.54	3.08	2.46	85
90	4.09	4.65	3.82	4.26	2.96	2.41	90
95	3.48	3.96		4	2.85	2.36	95
100	2.93	3.35		3.77	2.75	2.33	100
105	2.44	2.81		3.36	2.66	2.3	105
110	2	2.32		2.91	2.57	2.28	110
115	1.61			2.5	2.5		115
120	1.25			2.12	2.43		120
125				1.78	2.25		125
130				1.47	1.82		130
135				1.18	1.42		135